



EVERGREEN®

SONGSAN



SONGSAN SPECIAL ELEVATORS CO., LTD.

CONTENTS

- 04 History
- 06 Message from CEO
- 08 Goal & Vision
- 10 Quality Assurance & Awards
- 12 Product Line
- 14 Arch Elevator Constellation®
- 16 David Module Elevator®
- 18 Elvro3000®
- 20 Nuclear Power Plant
Explosion Proof Elevator®
- 22 Goliath Elevator®
Offshore Oil Plant
Shipyard & Marine
- 24 Evacuation X-vator®
- 25 Delta Inclined Elevator®
- 26 Nobah Clean Elevator®
- 27 Spara Panoramic Round Elevator®
- 28 Escalator SPEC901®
- 29 Moving Walk SPEC902®
- 30 S-Brake®
- 32 Major Project Records



SONGSAN GREEN TECHNOLOGIES

Songsan special elevators has been growing on a global scale over 20 years. We will continue to stay the course through a steadfast pursuit of excellence in engineering, project management, and corporate citizenship, in order to generate higher and more sustainable value. We will bring in a sustainable future for the global elevator industry by steadfastly creating new values.





EVERGREEN[®]

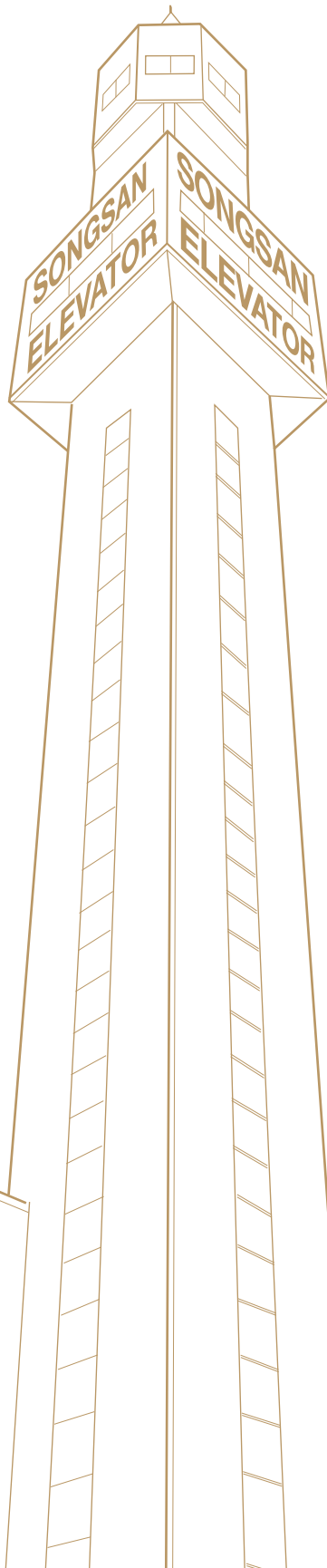



SONGSAN Green Technologies corporate philosophy is to Improve convenience and comfort for vertical transportation and contribute to Improving welfare of mankind through the development of world advanced technologies.



Songsan History



Year 2015~2011

- 2015** Developed Goliath Elevator[®] capacity 10 ton~50 ton(150~500prs), Exxon Mobil Corporation, Installed 300 passenger, Hebron project, Hyundai Heavy Industries.
Registered patent, Goliath Elevator[®]
Awarded 'The Best Management' by Deputy Prime Minister, Minister of Strategy and Finance
Incheon International Airport Extending Project III Passenger Modular Panoramic Elevators
Free Trading Area, Ulsan, Elevators
Universiade 2015, Center, Elevators UAE Barakah Nuclear Power Plant Elevators
- 2014** Awarded 'Trade Promotion' by Minister of Export Ministry of Trade, Industry, Energy
Awarded 'Export Tower Prize' by President of Korea, Park Geun-Hye
Contracted Explosion-Proof Elevators, Kavian Olefine Plant and Ethan Cracking Plant at Tehran, Iran
Contracted 'Hebron Project' Goliath Elevators, Exxon Mobil, Hebron
Awarded 'Certificate of Designation for an Excellent Company for overseas public procurement market' by Public Procurement Service of the Republic of Korea
Contracted 'Incheon International Airport', the 3rd terminal elevators
Elected President Mr.G. Y. Kim as Chairman of Korean Elevator Association
- 2013** Acquired the certification of OHSAS 18001 Health & Safety
Awarded 'The best Booth Design' at International Lift Expo 2013
Developed Modular-Top[®] Advanced MRL
Inclined Elevator 55M 20 passenger, Yongin Giheung Station
Installed the Second underground inclined Elevator 350M 48 passenger in the 3rd underground tunnel at DMZ
- 2012** Contracted Gimpo International Airport Elevators and Escalators of SMS
Contracted S-Brake[®] for Public Procurement Service, Republic of Korea
Acquired The Certificate of Good Design Selection from Korea Institute of Design Promotion and Ministry of Knowledge Economy
Awarded 'The best company' from Small & medium Business Ministry
Acquired the certificate of Designation of Excellent Product, S-Brake[®] from Public Procurement Service, Republic of Korea.
Acquired GOST R 52382 Certification, National Standard of Russian Federation,
Passenger & Freight Lifts
Acquired invention Patent & Certificate 'Protection Safety Brake Reversal Direction and Over Speed' S-Brake[®] for Escalator
- 2011** Contracted special elevators for UAE Barakah Nuclear Power Plant, Shin-Hanul Nuclear Power Plant

LEADING NEW TECHNOLOGIES OF SPECIAL ELEVATORS

We, SONGSAN SPECIAL ELEVATORS CO., LTD. will develop new technologies and do its endeavor in order to get the high quality and reliable products, satisfied by all of clients in the world.



Year 2010~2001

- 2010** Acquired Heliport Elevator[®] for the first in invention patent
Acquired the Certificate of Registration from KHNP and KEPCO, Nuclear Power Plant
- 2009** Acquired 'Excellent service quality' from Korean Government
Acquired invention Patent of elevator door deviation device
Acquired 'Evacuation Lift' X-vator[®] for the first invention patent
Acquired EK certificate,
Developed SONGSAN SPEC-901 HD escalators
Developed exclusive Heavy duty Escalator, Moving Walk for Rail station and Subway station
- 2008** Awarded from Minister of knowledge Economy
- 2007** Acquired the certificate of EMC of controller for Modular Elevator
Developed the World First, Arch Elevator Constellations[®]
- 2006** SONGSAN Special Maintenance System [SSMS] for Seoul Metro in Korea
Awarded from Commissioner of National Tax Service of Korea
- 2004** Awarded "Official Commendation from the seoul Mayor"
- 2003** Awarded "the Outstanding Award [INNO-BIZ] Technical Innovation
Acquired the certification of ISO 14001 Environmental management system
- 2002** Acquired the Authentication of K-Mark on Machine Room Less elevator by Korea Testing Laboratory
Installed the World Largest underground inclined Elevator 350M 48 passenger in the 3rd tunnel at DMZ
- 2001** Completed Sihwa Factory & Test Tower
Carried out Developing Business for High efficiency technical innovation

Year 2000~1994

- 2000** Exported to China Taiwan, Philippines, Thailand, Guam, Hongkong, Russia
Acquired "Excellent Quality Product" from supply Administration.
- 1999** Awarded Official Commendation from the president of Korea
Developed Machine Room Less Modular Elevator[®], the first in Korea
Acquired "Excellent Machine, Mechanism & Materials EM" Approval - by Ministry of Commerce, Industry & Energy
Awarded "Minister of Commerce, Industry & Resources Prize"
Selected as "Outstanding Technical Competitiveness Enterprise"
- 1998** Awarded "Outstanding Gyeonggi Minor Business Entrepreneur"
Established Songsan Technology Laboratory
Excellent Machines, Materials, and Mechanism
Acquired the Authentication of New Technology NT
- 1997** Developed Handylift[®] Products, for the first in Korea
- 1996** Developed Advanced Elvro-3000 VVF Elevator[®]
Developed Advanced Technology for G7 Gov. Project for special Lifts
- 1995** Developed innovated technologies for special elevators & Lifts
Acquired the certification of ISO 9001 Quality management system
- 1994** Established SONGSAN Special Elevators Co.,Ltd.





Evergreen Songsan Technologies



CEO's Message

Dear prospective customers,

We are very proud of our corporate ideal "Evergreen Songsan Technologies" We have been strongly committed to based upon our love of human beings, safety and nature.

We stand firm for leading the vertical transportation industry by providing the safest and most convenient products, and excellent customer support for the benefit of our customers.

Songsan has made brilliant achievements since its foundation in 1994. Right after birth, with ingenuity and technological advancement, Songsan succeeded first time in Korea in developing special elevators not only for meeting domestic demands but for demands from abroad over 20 countries.

In 1998, Songsan developed the Modular Elevator[®] patented MRL and inclined elevator the first in Korea. In 2002, 350M underground Inclined elevator was successfully developed and installed for passengers in the third tunnel at DMZ in Korea. In 2015, developed Goliath elevator[®] 10ton~50ton, 150~500 passenger and freight elevators for Offshore Oil Plant, Shipyard & Marine.

Songsan's technological advancement and high quality have been continuously recognized by various awards, certifications and advanced products as Modular[®], Arch Elevator Constellations[®], Evacuation X-vator[®], Elvro[®] Heavy duty, Nobah Clean Elevator[®], Explosion Proof, Goliath[®], David Module Elevator[®], Delta Inclined Elevator[®] and Escalator Spec901. Songsan will also be a leading manufacturer in the development of eco-friendly Wellness[®] Elevators.

With the continued trust and support of our customers, we will overcome all challenges with our dedication and passion, and engage prosperously in the future.

Thank you again for your interest in Songsan Evergreen Technologies and Solutions.

Gi-Young Kim Ph.D.
CEO, SONGSAN Special Elevators
Chairman, Korea Elevator Association



Goal & Vision

GOAL



Secure Global Leading Technologies and Quality Competitiveness



Maximize Synergy through Collaboration with related Global Partner



Realize Good Corporate Songsan Culture, Evergreen Pine Tree Mountain

VISION

Global Elevator Specialist & Leader

■ Focus on Customer Value



■ Secure Safety on all occasions

■ Develop the best Global Technologies

COMPANY MISSION

Evergreen SONGSAN Technologies

■ Secure Human beings



■ Secure Nature

■ Secure Safety

GLOBAL NETWORK

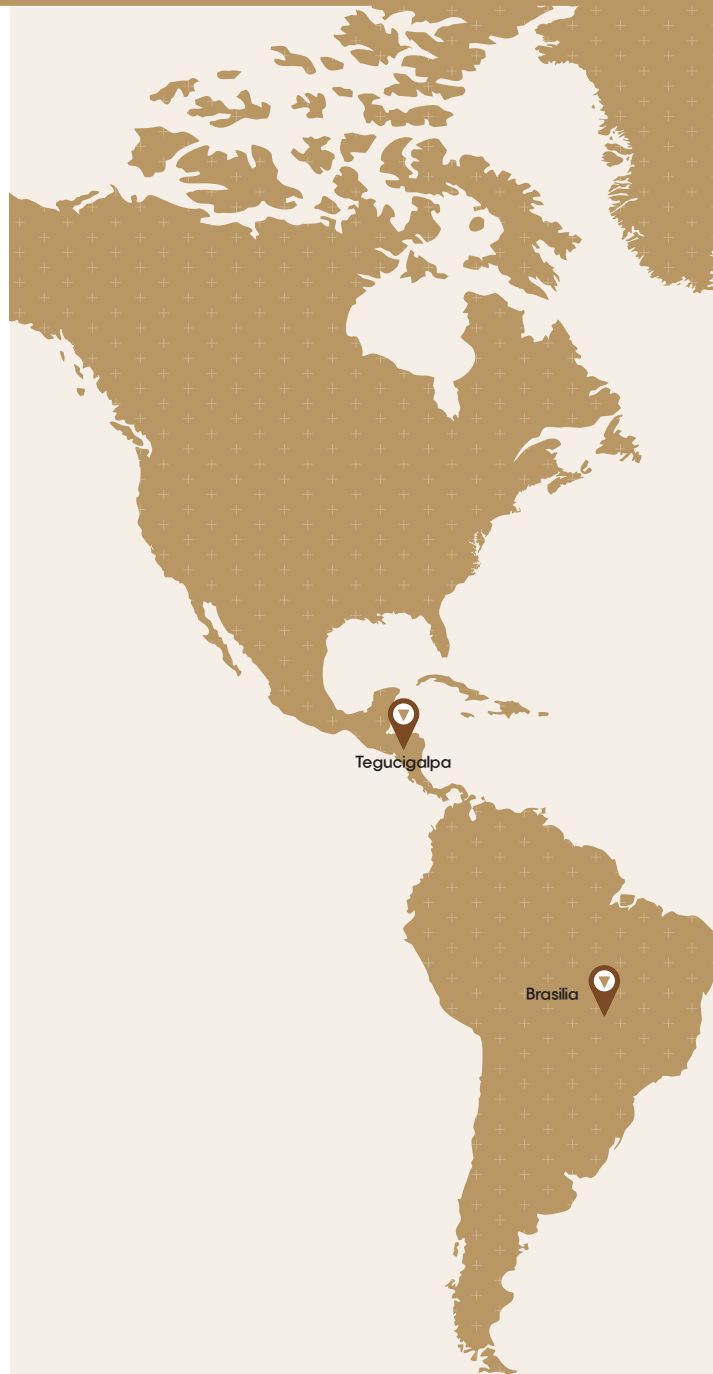

Head Office / Factory

65, Mayu-ro 70 beon-gil Siheung City, Gyeonggi-do, 15113, Korea

Customer service center and Local office

Seoul	Gwanju	Samsung
Busan	Anyang	Seoul International Airport
Daejeon	Ulsan	Nongshim
Daegu	Cheonan	Geoje

SONGSAN, THE GLOBAL SPECIALIST OF ELEVATOR CORPORATE

SONGSAN is born again now as a high value-added global enterprise. New competitive power of technology is the foundation of the SONGSAN growth, and the new competitive power of technology is being prepared upon the foundation of growth.



Overseas Sales Office & Partners

Tegucigalpa
Brasilia
Guam
Addis Ababa
Tripoli
Cape Town
Moscow

Vladivostok
Saint Petersburg
Yekaterinburg
Khabarovsk
Novosibirsk
Sochi
Yakutsk

Irkutsk
Kazan
Tver
Ulan-Ude
Omsk
Teheran
Riyadh

Dubai
Abu Dhabi
New Delhi
Mumbai
Kolkata
Vadodara
Ashkhabad

Ulaanbaatar
Astana
Almaty
Tashkent
Manila
Shanghai
Tianjin

Bangkok
Taipei
Dhaka
Chittagong

Songsan Special Elevators makes only the world's best.

SONGSAN products made with the best passion and technology are already being exported to more than 20 countries. SONGSAN products are performing their best everywhere seen or unseen, making everyone's lives more convenient and beneficial. SONGSAN will continue to provide quality products and customer service. SONGSAN will be with our customers on the way to the better future.



Quality assurance & Awards

Certificates of Quality



ISO 9001



ISO 14001



Certificate of X-vator



K-Mark Certificate
Elevator Controller



K-Mark Certificate
MRL Control System



GOST Certificate
Russia & CIS

Letter of a patent



Turkey Certificate



Kazakhstan Certificate



Russian Patent
Arch Elevator Constellation

QUALITY ASSURANCE & AWARDS



Excellent Machines
Materials, and Mechanism



Korea Service Quality
Excellent Company



Certificate of New Technology



Safety Certificate



K-mark EMC for MRL Elev.



X-vator from
Korean Intellectual Property Office



Excellent Quality Product
from Supply Administration



Outstanding Technical
Competiveness Enterprise



'The Best Company'
Small & Medium Business Ministry



Certificate OHSAS 18001
Health & Safety

INNOBIZ

INNO-BIZ Technical Innovation Category
by the Governor of Gyeonggi Province



Certificate of
Good Design Selection

MAIN Biz

MAIN-Biz Management Innovation Category
by the Governor of Gyeonggi Province



Certificate ISO 9001 Quality management system
Certificate ISO 14001 Environmental management system





Product Line

CREATIVITY & INNOVATION

By harnessing proprietary techniques, pursuing excellence in design and construction planning, we are envisioning ever-taller and more sustainable products. City by city, continent by continent, we are changing the skylines of the world.

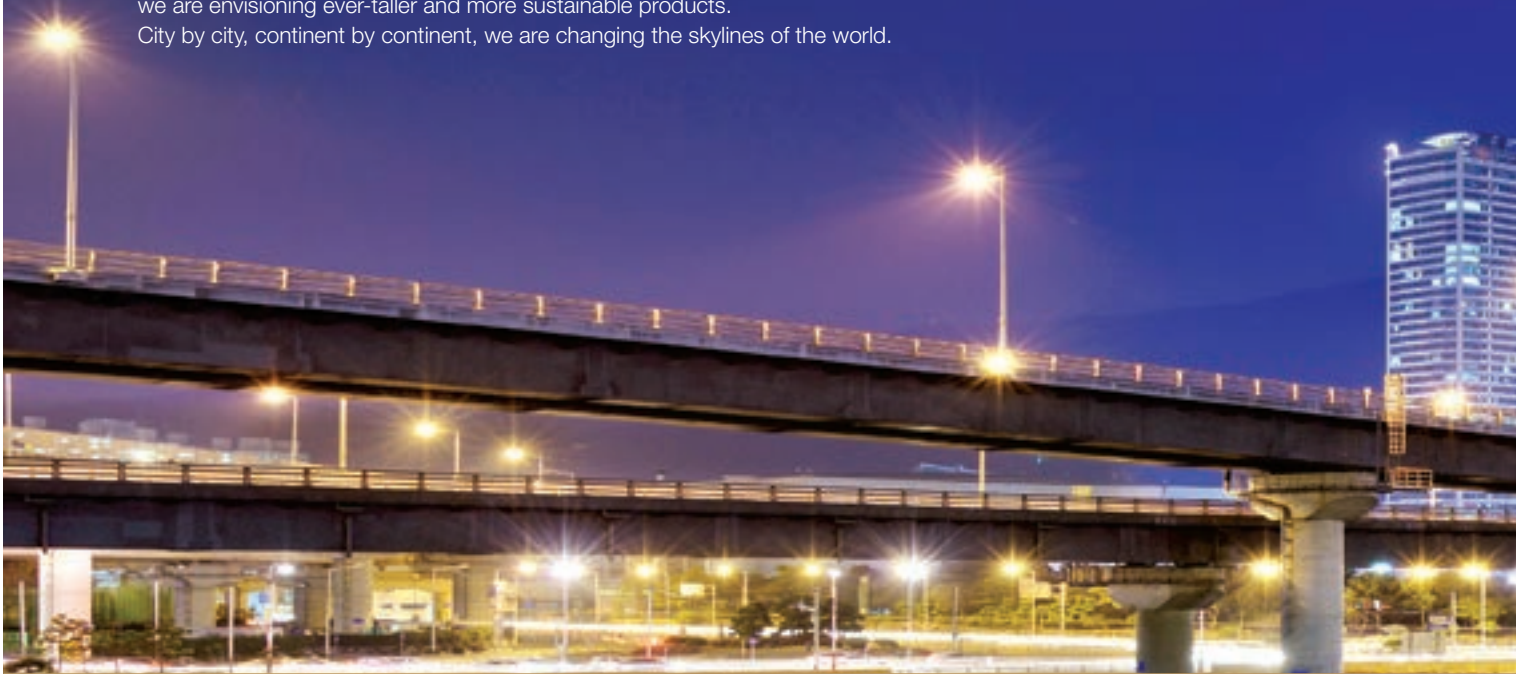

01

Arch Elevator Constellation®



05

Explosion Proof Elevator®



02

David Module Elevator®



06

Goliath Elevator® Shipyard



03

Elvro3000®



07

Goliath Elevator® Offshore Oil Plant



04

Nuclear Power Plant Elevator®



08

Marine Elevator





09

Evacuation
X-vator®

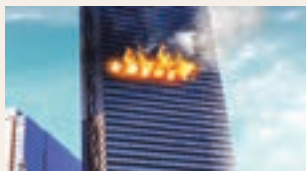

10

Delta Inclined
Elevator®



13

Escalator
SPEC901®



11

Nobah Clean
Elevator®



14

Moving Walk
SPEC902®



12

SPARA Panoramic
Round Elevator®



15

S-Brake®





Arch Elevator Constellation®

Highly luxurious Arch Constellation Elevator with arch style design not only supplies comfortable and convenient spatial feeling by providing highly effective space layout but also elevate the elegance of architectural space through ultramodern creative design.



1 The first arch elevator in the world
Design Patent no.0375054

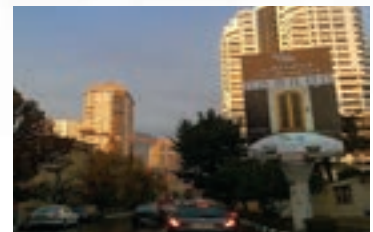

2 The world first arch elevator at Tehran, Iran



Special Advantages of Round Entrance Elevator

- High graceful design : Arch type design used at ancient palace, triumphal arch etc. was applied to elevator first time in the world, and we supply distinguishable high graceful visual space than existing elevator.
- By dispersing the vertical gravitational pressure to the sides with unique capability of arch configuration, the elevator provides safer structure than general elevators.
- Arch Entrance Elevator provide elegant and comfortable spatial feeling when getting on and off the elevator with increased effective height of 100~300mm at entrance than general elevators.



DAVID MODULE ELEVATOR[®]

David Module Elevator[®] does not require separate machine room which is essential in existing normal type elevator, instead, it has traction motor, control panel and safety system inside of hoistway by modules, which is a new concept elevator that saves space and construction expense. Permanent magnetic gearless traction motor is located upper and intermediate of hoistway, and controller is located at hall side, beside doors.





Concerning architecture

- Does not require additional space for machine room
- Does not required to raise top floor.
- Location of elevator components will be unrestricted
- Enlargement of building and replacement will be convenient and economic
- Cost of construction and mechanical works will be reduce remarkably
- Can be installed without any modification of structure, where general elevator can not be installed.
- Maintenance will be convenient and economical.
- Unique MRL driving type without change of dimension of standard hoistway.



ELVRO 3000[®]



Improving productivity for vertical transportation at building site cutting-edge performance and high quality can be realized with SONGSAN Elvro 3000. Industrial elevator of SONGSAN has been leading the vertical transportation in local and overseas building project sites with high quality and complete performance.



1

1 Presidential House in Taiwan
2 Russia Government Hospital

3 Geoje Art Center
4 Suwon Gwonseon Pedestrian Bridge

5 Samsung Corning



Explosion-proof lifts for the chemical and petro-chemical industries

Industrial and non-standard special elevator ELVRO 3000 such as large capacity high rise elevator with load capacity 1,000~20,000kg, dustproof clean elevator, moisture-proof elevator for places with lots of moisture, explosion-proof lift for chemical industry buildings where danger of explosion is present. Top maker in special elevating facilities, SONGSAN, applies

various optional features according to customer needs based on specialized KNOW-HOW on the elevators and ultra modern technology. SONGSAN has been establishing highest fame and myth with complete and through after service considering customer's safety and convenience first.



Nuclear Power Plant Elevator®

Explosion Proof Elevator®

Special industrial purpose elevators, Explosion proof Elvro3000, such as chemical plants, Nuclear power plants, Oil refinery plants and etc., securing human beings and high-valued production facilities from explosion caused by dangerous chemical plants and nuclear power plants.

Barakah Nuclear Power Plant at Abu Dhabi, UAE

Shin-Hanul Nuclear Power Plant in Korea

BASF factory at Ulsan, Korea

Kavian Olefine Plant and Ethan Cracking Plant at Dubai, UAE

IOCL Barauni Refinery Plant in India







Goliath Elevator[®]

Offshore Oil Plant Shipyard & Marine

Based on accumulated manufacturing experience and technical know-how of Goliath Elevator[®] Songsan is able to supply various kinds of special elevators such as gigantic capacity of cabin and rated load, 300 passengers, 20 tons rated load, special elevators installed for offshore oil plant and shipyard.

Recently in 2015, gigantic elevator, 300 passengers, 20 tons are produced by SONGSAN and installed for Hebron project, ordered by Exxon Mobil, Aasta Hansteen project, ordered by Statoil, Hyundai Heavy Industries and INPEX ICHTHYS CPF project, ordered by INPEX Corporation, Samsung Heavy Industries. It is the world largest passenger elevator.

Quality assurance & Patent



Trademark Registration of Goliath Elevator



Invention patent of Goliath Elevator







Evacuation *X-vator*[®]

In case of fire in High-rise building, Emergency rescue Elevator



Emergency Evacuation Purpose Elevator for High Rise Building

On firing in high rise building, incoming and spread out poisonous gas, flame and smoke, and then Evacuation X-vator can rescue residents safely with new generation technology system. And it prompts resident staying high-rise floors and handicapped happiness in comfortable and safety condition. X-vator normally uses and operates as normal passenger elevator and it can be installed in a standard hoistway dimension without any additional construction. In order to avoid and effective evacuation from increasing firing disasters in complicated down town the regulation in Korea requests evacuation elevator, X-vator as an obligation for more than 30 stories buildings.

- 01 | Composition of Emergency rescue Elevator
 Hoistway air purification jet cut-off system
 Water-proof, fire-proof, Explosion-proof,
 electric control device & system
 Emergency rescue device
 High credibility of driving system
- 02 | Emergency drainage pump
 Overspeed governor
 Guided laser beam & audioguide device
 Fire detecting sensor & control system
 Fire-proof door system at outside exit
 Blocking poisonous gas & flame system
- 03 | Controller for emergency rescue
 Driving self supply power at emergency
 Auto shift device at Emergency operation system
 in power failure
 Hoistway pressure control system

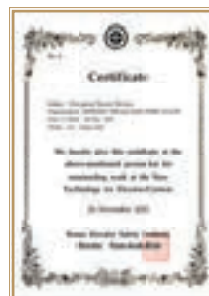

Certificate of X-vator



Invention Patent of X-vator



DELTA INCLINED ELEVATOR®

Inclined elevator is developed and applied for the physically disabled, the elderly, pregnant women, baby carriage, patients and also normal passengers installed at riverbed parks, mountainous area, facilities for the elderly, recreational & leisure facilities, short-distance transportation, golf cart transportation, Shipyard and Offshore oil Plant

- 1 Everland Giheung Station
- 2 The World Largest Underground Inclined Elevator in the 3rd Tunnel of DMZ
- 3 Yangjaecheon Seoul The First Inclined Elevator in Korea





Songsan has supplied many projects with major semi-conducts factories and food factories such as Samsung, Nongshim and etc. more than 20 years.



In order to keep high-purity condition of special products such as semi-conduct, clean-room facilities, food company, cooking facilities for hotels and convention centers clean-room elevator with special devices, installed with advanced cleaning system, filters in cabin ceiling and hoistway, various

special joints between panels, protecting from dust, inflection air, bacterium, insects, dirty and pollution, and double folded and antistatic tile in cabin floor avoiding dust onto floors, is up graded of comfortable condition of elevator cabin than conventional elevators and keep elevator cabin with higher purity.





SPARA Panoramic Round Elevator[®]

According to up-grade of elevator, SPARA[®] with creative ultramodern design, elegant glass exterior and excellent ride quality upgrades the elegance of architecture more.

Completion of structure's internal design. Special Panoramic Design.

SONGSAN's high quality elevator upgrades completeness of architecture with passenger's convenience, creative ultramodern panoramic design and excellent ride. Also, as it is designed and manufactured specially according to customer's order, occupies minimum space and presents individually the harmonization with architecture.





Escalator SPEC901[®]

Full automated energy control system automatically senses travel speed of escalators and its load weight, and have realized optimal driving control and energy saving system.



Best performance on energy saving

Alpha-plus System controlling automatically best transportation efficiency at all times by automatic operation recording system. Remote control service system, SMS CS System, controlled by on-line can be applied as an optional specification.

Putting much value on the characteristics of architecture and each different operation condition, satisfaction of passenger is also carefully considered from the early stage of design, and needs of customer is also reflected to highly elegant escalators

outdoor weather proof and moving walks established by ultra high technological design and innovation.



1 Yangpyung Station 2 Hoeryong Station 3 Namwon Chunhyang Park 4 Asia Culture Center



Moving Walk SPEC902[®]

Moving walks of SONGSAN are made by uppermost technology of SONGSAN making inconvenient and hard vertical horizontal movement convenient and Moving walks have become not only economical and transportation efficiency but also essential facilities of aesthetic and magnificent living spaces as safe and comfortable continuous transportation means in airports, railroad stations, subway stations, terminals, shopping centers, public places etc.





S-Brake[®]



- 01 | S-Brake will protect you safely from any cause of Reversing accident & Overspeed accident.
S-Brake escalator safety brake prevents any cause of Reversing accident & Overspeed accident from any mechanical, electrical, or electronic reason as like Service brake breakdown, Chain disconnection, Control Malfunction, Main power failure, uncontrolled movement, etc. S-Brake escalator safety brake will protect a passenger safety from accidents & injury.
- 02 | You can install S-Brake at your escalator & moving walks. Even if it is already running.
You can easily install S-Brake escalator brake during off business hour without structure change.
- 03 | You can apply S-Brake at your new escalator & moving walks.
You can easily install S-Brake without reconfiguration regardless of manufacturer and model type. Also, S-Brake effectively substitute escalator safety brakes defined at EN115 for high rise escalator.
- 04 | Strong & Smooth!! Patented new technology hydraulic break type safety device S-Brake
Patented new technology S-Brake, in the 30m height, 18tib rate load Reversing & Overspeed accident test, it is proving it's safe performance by enough brake force & less than 1m/sec deceleration.
- 05 | Korea Product Safety code, EN115-1, ASME A17.1, ISO Escalator safety code 100% satisfied
S-Brake is 100% completely safety Korea Safety code & EN115-1
- 06 | You can use S-Brake for additional escalator safety brake with simple connection
S-Brake is easy to connect with exist safety switches & it will work for additional escalator safety brake.
S-Brake will stop your escalator in safety, even if main brake is not work for brake failure.



Excellent performance certification



Certificate of designation of excellent product



Certificate of designation of excellent product



Patent of S-brake



Patent of S-brake



Korea Service quality excellent company

S-Brake® Product Structure



The final guard for an escalator passenger Songsan S-Brake®

Reversing accident & Overspeed accident solution

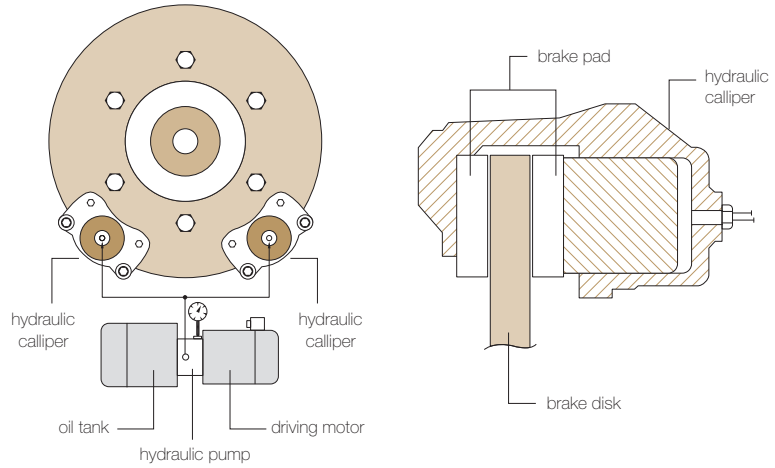

S-Brake® Solution



Q1 Is it really safe from Reversing accident & Overspeed accident, regardless of escalator model type or escalator condition?

Ans Yes it is. S-Brake protect passengers safely by stopping driving shaft at the moment of Reversing accident & Overspeed accident causing by any reason

Q2 Isn't S-Brake out of order?

Ans It seldom happen. In that case S-brake failure circuit is activating it stop escalator safely

Q3 Where is S-brake installed in escalator?

Ans S-Brake install at driving shaft center or side part of escalator

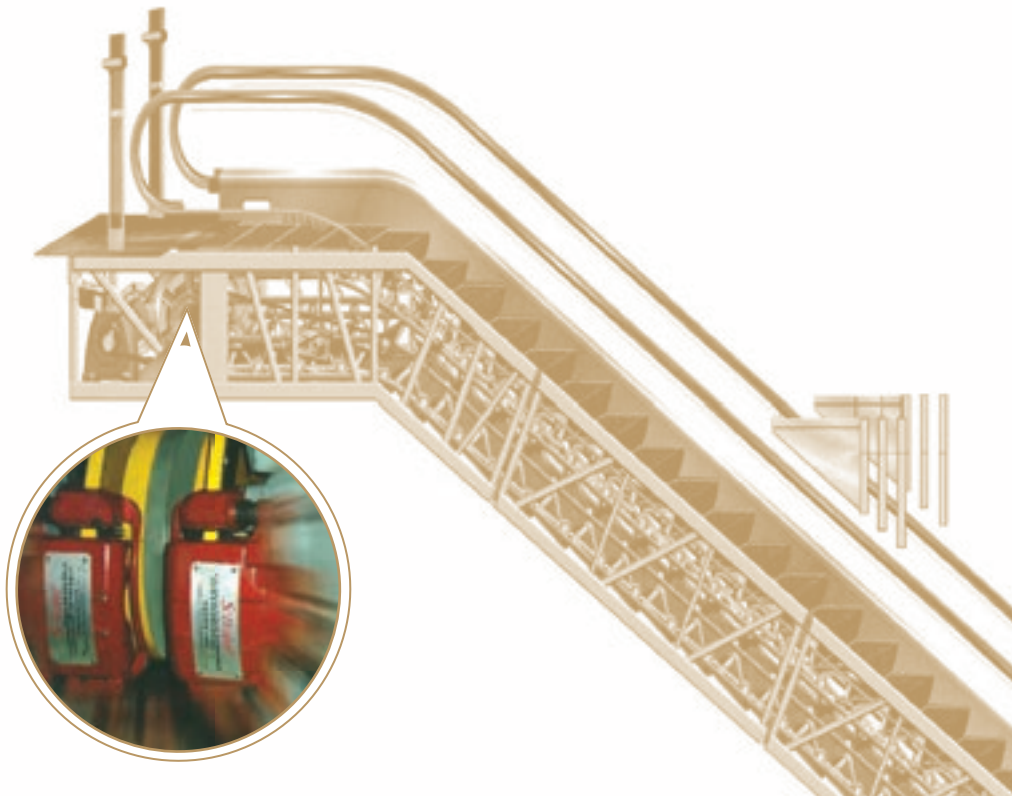

S-Brake® System



Revolution for the safe of Escalator
New technology lead a safe driving

Perfect solution for existing escalators and new installion,
"Reversing accident & overspeed accident"

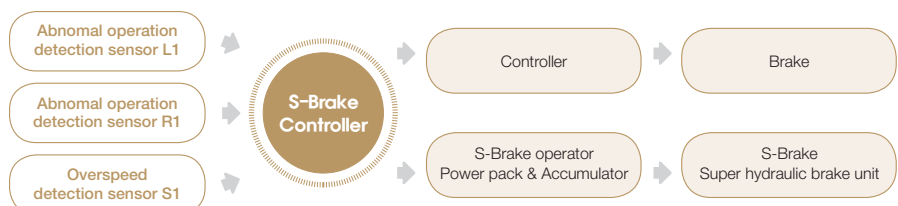

Major Project Records

TRANSPORTATION



- Incheon International Airport
- Seoul International Airport
- Tehran Imam Khomeini International Airport
- Seoul Central Express Bus Terminal
- Seoul South Bus Terminal
- Busan Port Authority

RAILROAD & METRO STATION



- Korail Stations
- Seoul Metro Stations
- Incheon Metro
- Daegu Metro
- Kwangju Metro
- Stations Busan
- Station Tianjin China

INDUSTRY



- HYUNDAI Heavy Industries
- SAMSUNG Heavy Industries
- Exxon Mobil
- Statoil
- INPEX Corporation
- Hyundai Glovis
- Hyundai Mobis
- LG Chemistry
- Daewoo Heavy Industries
- Korea Electric Power Corporation
- Korea Hydro & Nuclear Power Co.,Ltd
- Korea Industrial Complex Corporation
- POSCO
- Nongshim
- Fursys
- Yuhan-Kimberly
- Larsen & Toubro hydrocarbon engineering
- BASF
- Engineers india limited
- kolon
- Toyo Engineering
- Indian Oil Corporation Limit

GOVERNMENT BUILDING



- Korea National Assembly Building
- Korea food & Drug administration
- Buyeo minting and security printing corporation
- The board of audit and inspection
- Korea culture & content agency
- Seoul Metropolitan Government
- Government Buildings
- Presidential House in Taiwan
- City Hall of Moscow

SHOPPING CENTER & DEPARTMENT STORE



- Lotte Department Store
- Observation Elevator
- Passenger Elevator
- Seoul Club
- Vladivostok Department Store
- Kwanghee Market

UNIVERSITY & SCHOOL



- Seoul Municipal University
- Masan University
- Kangwon University
- Daegu University
- Jeju International City
- Taiwan University

RESIDENTIAL BUILDING



- SK Center
- Dongwon Apartment
- Dongbu Building Exhibition
- KCC
- Daelim
- Seoul Foreign Apartment
- Guhwa Building
- Florans Moscow
- Verhnaya Pishma
- To Letvinova
- Patriska Lumunbi
- Komsom Tver
- Ordginkidze
- Detskaya Bolnica
- Alinghian's Building
- Teheran Razi Building
- Sama University
- Maloul Building

HOSPITAL & WELFARE



- Hongcheon Disabled Welfare Society
- Samsung Electronics Welfare Center
- Kim's oriental medical clinic
- Bupyeong Best Medical
- Government Children Hospital In Tver City
- Sharing Fountain Nursing Home
- Shin & Park Ophthalmology Clinic

MUSEUM & CULTURAL



- Seoul Savina Museum
- Kwangju Asia Cultural Complex
- leYoung Art Center
- Seongbuk Library
- Shiheung Welfare Center
- Daejeon World Cup Stadium
- Chungju National Sports Center

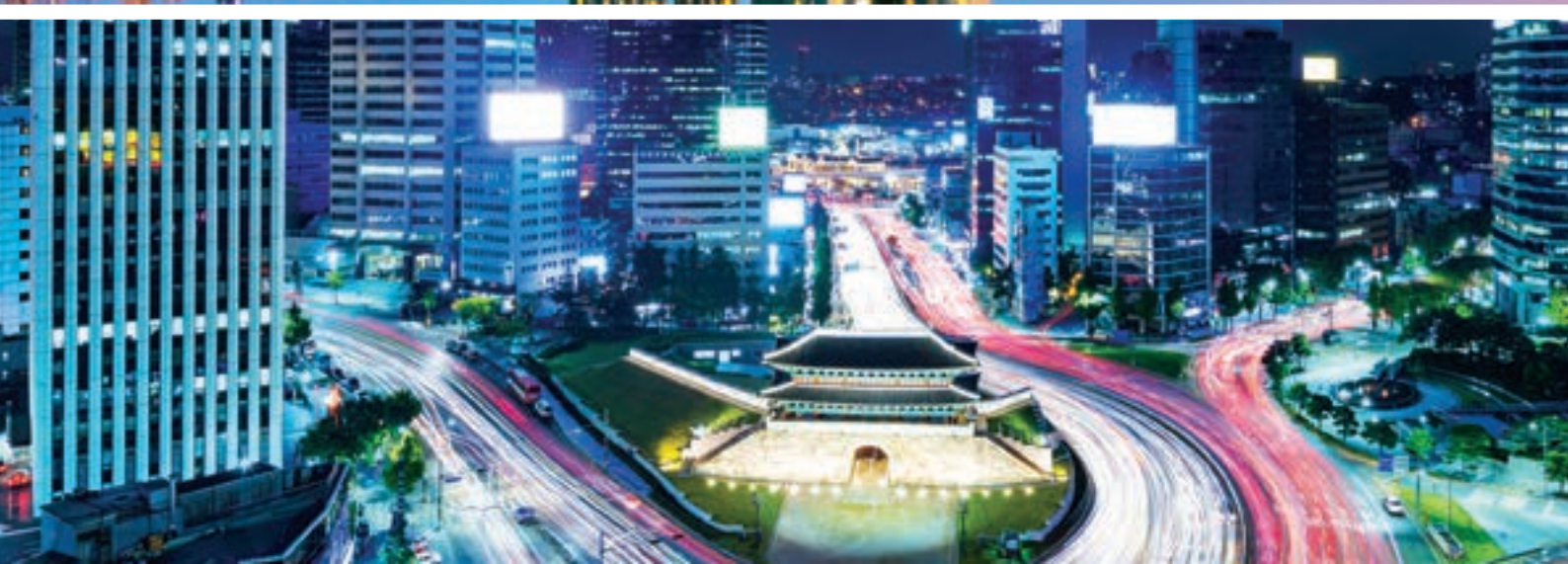





SONGSAN SPECIAL ELEVATORS CO., LTD.

Head Office / Factory

65, Mayu-ro 70beon-gil Siheung City, Gyeonggi-do, 15113, Korea
Tel:+82 31 433 2255 Fax:+82 31 433 6295
[http : //www.songsan.co.kr](http://www.songsan.co.kr)
e-mail : songsan@songsan.co.kr

Customer service center and local office

Seoul, Busan, Samsung, Daejeon, Daegu, Ulsan, Anyang, Geoje
Seoul International Airport, Nongshim

Oversea marketing dept.

TEL : +82 31 433 9671 Contact : Sophia Kim
e-mail : omd@songsan.co.kr

Overseas Partners

Russia, Kazakhstan, Uzbekistan, Turkmenistan, Myanmar, Mongolia, South America
Saudi Arabia, Iran, UAE, Bangladesh, Malaysia, China, Taiwan, South Africa, Philippines